

Tij Tavan Tespit Elemanları

Threaded Rod Ceiling Fixing Part
Резьбовой потолочный крепежный элемент

Sipariş Kodu Order Code Код заказа	Kalınlık Thickness Толщина (mm)	Ağırlık* Weight вс (Kg/unit)	Ağırlık** Weight вс (Kg/unit)
KSRTT-1	3.00	0.137	0.146

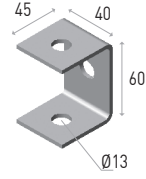

Tavan Tespit Elemanı

Ceiling Fixing Part
Потолочный крепежный элемент

Sipariş Kodu Order Code Код заказа	Kalınlık Thickness Толщина (mm)	Ağırlık* Weight вс (Kg/unit)	Ağırlık** Weight вс (Kg/unit)
KSRTT-2	2.00	0.105	0.112
KSCS-M8X110	M8	0.050	0.050

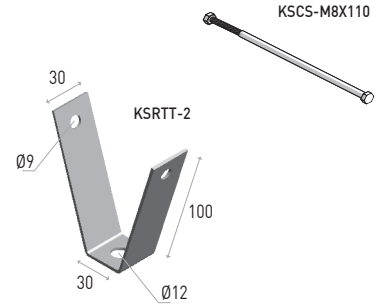

Tavan Tespit Elemanı

Ceiling Fixing Part
Потолочный крепежный элемент

Sipariş Kodu Order Code Код заказа	Kalınlık Thickness Толщина (mm)	Ağırlık* Weight вс (Kg/unit)	Ağırlık** Weight вс (Kg/unit)
KSRTT-3		0.150	0.150

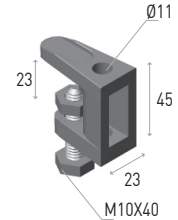

Tijle Kanal Taşıyıcılar

Tray Carriers With Threaded Rod
Резьбовые каналные подвески

Sipariş Kodu Order Code Код заказа	Kalınlık Thickness Толщина (mm)	Ağırlık* Weight вс (Kg/unit)	Ağırlık** Weight вс (Kg/unit)
KLP-40	2.00	0.042	0.045

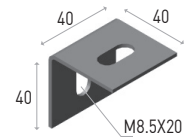

Tij Tavan Montaj Elemanları

Threaded Rod Ceiling Mounting Part
Резьбовой потолочный монтажный элемент

Sipariş Kodu Order Code Код заказа	Uzunluk Length Длина (mm)	Kalınlık Thickness Толщина (mm)	Ağırlık* Weight вес (Kg/unit)	Ağırlık** Weight вес (Kg/unit)
KSRTT-100-200	160	2.00	0.262	0.282
KSRTT-160-200	220	2.00	0.354	0.381
KSRTT-200-200	260	2.00	0.405	0.437
KSRTT-250-200	310	2.00	0.513	0.552
KSRTT-300-200	360	2.00	0.564	0.608
KSRTT-400-200	460	2.00	0.733	0.789
KSRTT-500-200	560	2.00	0.882	0.950
KSRTT-600-200	660	2.00	1.041	1.122

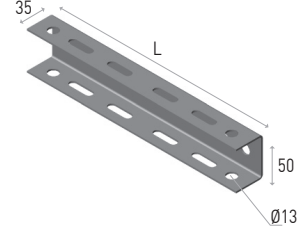

Tijli Kiriş Montaj Elemanı

Beam Mounting Part With Threaded Rod
Резьбовой балочный монтажный элемент

Sipariş Kodu Order Code Код заказа	Uzunluk Length Длина (mm)	Kalınlık Thickness Толщина (mm)	Ağırlık* Weight вес (Kg/unit)	Ağırlık** Weight вес (Kg/unit)
KSRKT-100-200	160	2.00	0.162	0.175
KSRKT-160-200	220	2.00	0.216	0.233
KSRKT-200-200	260	2.00	0.242	0.263
KSRKT-250-200	310	2.00	0.312	0.337
KSRKT-300-200	360	2.00	0.338	0.367
KSRKT-400-200	460	2.00	0.444	0.480
KSRKT-500-200	560	2.00	0.531	0.575
KSRKT-600-200	660	2.00	0.627	0.679

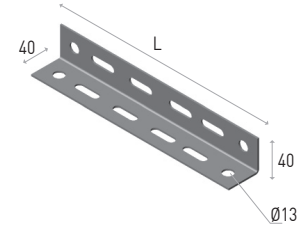

Tijle Kanal Taşıyıcılar

Tray Carriers With Threaded Rod
Резьбовые каналные подвески

Sipariş Kodu Order Code Код заказа	Uzunluk Length Длина (mm)	Kalınlık Thickness Толщина (mm)	Ağırlık* Weight вес (Kg/unit)	Ağırlık** Weight вес (Kg/unit)
KSRA-100-200	160	2.00	0.162	0.175
KSRA-160-200	220	2.00	0.224	0.241
KSRA-200-200	260	2.00	0.262	0.283
KSRA-250-200	310	2.00	0.332	0.357
KSRA-300-200	360	2.00	0.373	0.402

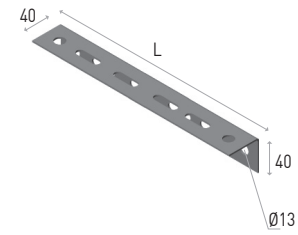

Tijle Kanal Taşıyıcılar

Tray Carriers With Threaded Rod
Резьбовые каналные подвески

Sipariş Kodu Order Code Код заказа	Uzunluk Length Длина (mm)	Kalınlık Thickness Толщина (mm)	Ağırlık* Weight вес (Kg/unit)	Ağırlık** Weight вес (Kg/unit)
KSRA-400-200	460	2.00	0.733	0.789
KSRA-500-200	560	2.00	0.882	0.950
KSRA-600-200	660	2.00	1.041	1.122

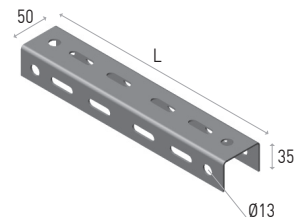

Ağırlık* Pregalvaniz ürünlerin, birim ağırlığıdır. Ağırlık** Sıcak Daldırma Galvaniz kaplamalı ürünlerin, birim ağırlığıdır.
Weight* This weight is unit weight of Pregalvanized products. Weight** This weight is unit weight of Hot-dip galvanization coated products.
Вес* Вес единицы предварительной оцинкованных изделий. Вес** Вес единицы оцинкованных изделий горячим погружением.

Tijli Kanal Taşıyıcılar

Tray Carriers With Threaded Rod
Резьбовые канальные подвески

Sipariş Kodu Order Code Код заказа	Genişlik Width Ширина (mm)	Kalınlık Thickness Толщина (mm)	Ağırlık* Weight вес (Kg/unit)	Ağırlık** Weight вес (Kg/unit)
KSRK-050-150	55	1.50	0.081	0.088
KSRK-070-150	75	1.50	0.091	0.099
KSRK-100-150	105	1.50	0.107	0.117
KSRK-120-150	125	1.50	0.117	0.128
KSRK-160-200	165	2.00	0.183	0.196
KSRK-200-200	205	2.00	0.211	0.226
KSRK-250-200	255	2.00	0.253	0.271
KSRK-300-200	305	2.00	0.280	0.300

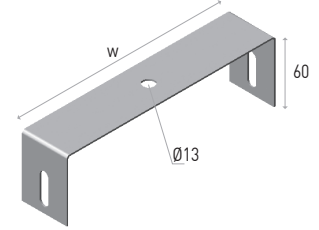

Tijli Kanal Taşıyıcılar (Yatay)

Tray Carriers With Threaded Rod (Horizontal)
Резьбовые канальные подвески (горизонтальные)

Sipariş Kodu Order Code Код заказа	Genişlik Width Ширина (mm)	Kalınlık Thickness Толщина (mm)	Ağırlık* Weight вес (Kg/unit)	Ağırlık** Weight вес (Kg/unit)
KSCK-050-300Y	60	3.00	0.204	0.215
KSCK-070-300Y	80	3.00	0.232	0.245
KSCK-100-300Y	110	3.00	0.274	0.289
KSCK-120-300Y	130	3.00	0.302	0.318
KSCK-160-300Y	170	3.00	0.359	0.378
KSCK-200-300Y	210	3.00	0.415	0.437

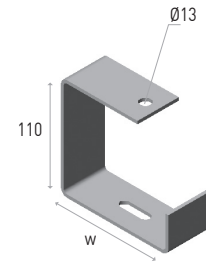

Tijli Kanal Taşıyıcılar (Dikey)

Tray Carriers With Threaded Rod (Vertical)
Резьбовые канальные подвески (вертикальные)

Sipariş Kodu Order Code Код заказа	Genişlik Width Ширина (mm)	Kalınlık Thickness Толщина (mm)	Ağırlık* Weight вес (Kg/unit)	Ağırlık** Weight вес (Kg/unit)
KSCK-050-300D	60	3.00	0.109	0.115
KSCK-070-300D	80	3.00	0.128	0.135
KSCK-100-300D	110	3.00	0.156	0.165
KSCK-120-300D	130	3.00	0.175	0.185
KSCK-160-300D	170	3.00	0.213	0.225
KSCK-200-300D	210	3.00	0.251	0.265

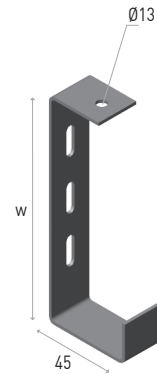

Ağırlık* Pregalvaniz ürünlerin, birim ağırlığıdır. Ağırlık** Sıcak Daldırma Galvaniz kaplamalı ürünlerin, birim ağırlığıdır.
Weight* This weight is unit weight of Pregalvanized products. Weight** This weight is unit weight of Hot-dip galvanization coated products.
Вес* Вес единицы предварительной оцинкованных изделий. Вес** Вес единицы оцинкованных изделий горячим погружением.

Askı Tijleri ve Somunlar

Hanger Threaded rod and Nuts
Резьбовые подвески и гайки

Sipariş Kodu Order Code Код заказа	Uzunluk Length Длина (mm)	Diş Ölçüsü Thickness Толщина (mm)	Ağırlık* Weight вс (Kg/unit)
KSR-M8X500	500	M8	0.151
KSR-M8X1000	1000	M8	0.302
KSR-M8X2000	2000	M8	0.604
KSR-M10X500	500	M10	0.239
KSR-M10X1000	1000	M10	0.478
KSR-M10X2000	2000	M10	0.956
KSR-M12X500	500	M12	0.356
KSR-M12X1000	1000	M12	0.712
KSR-M12X2000	2000	M12	1.424
KSS-M8	M8 Somun	M8	0.004
KSS-M10	M10 Somun	M10	0.010
KSS-M12	M12 Somun	M12	0.014
KSUS-M8	M8 Uzatma Somunu	M8	0.030
KSUS-M10	M10 Uzatma Somunu	M10	0.036
KSUS-M12	M12 Uzatma Somunu	M12	0.038
KSP-M8	M8 Pul	M8	0.0007
KSP-M10	M10 Pul	M10	0.001
KSP-M12	M12 Pul	M12	0.0014

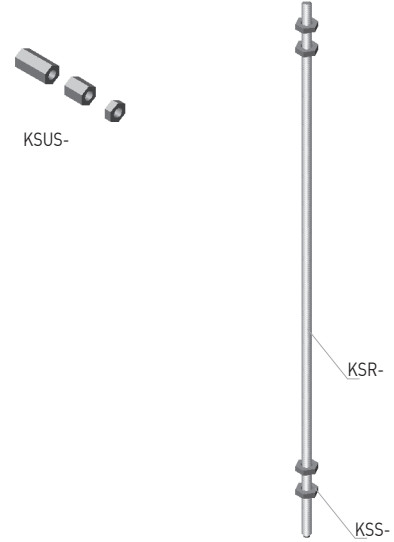

Çelik Dübel, Civata, Kopilya

Expansion Bolt, Bolt, Pin
Стальной дюбель, болт, штифт

Sipariş Kodu Order Code Код заказа	Açıklama Comment объяснение	Ağırlık* Weight вс (Kg/unit)
KŞÇD-M6	M6 Çekmeli Tip Çelik Dübel	0.020
KŞÇD-M8	M8 Çekmeli Tip Çelik Dübel	0.045
KŞÇD-M10	M10 Çekmeli Tip Çelik Dübel	0.075
KŞÇD-M12	M12 Çekmeli Tip Çelik Dübel	0.100
KŞÇD-M6	M6 Çakmalı Tip Çelik Dübel	0.012
KŞÇD-M8	M8 Çakmalı Tip Çelik Dübel	0.026
KŞÇD-M10	M10 Çakmalı Tip Çelik Dübel	0.035
KŞÇD-M12	M12 Çakmalı Tip Çelik Dübel	0.080
KŞÇSD-M6	M6 Sac Gömleklili Tip Çelik Dübel	0.014
KŞÇSD-M8	M8 Sac Gömleklili Tip Çelik Dübel	0.019
KŞÇSD-M10	M10 Sac Gömleklili Tip Çelik Dübel	0.063
KŞÇSD-M12	M12 Sac Gömleklili Tip Çelik Dübel	0.118
KSCS-M8X15	M8x15mm Bombe Başlı Civata-Somun	0.014
KSK-8X80	8x80mm Kopilya	0.030



Ağırlık* Pregalvaniz ürünlerin, birim ağırlığıdır. Ağırlık** Sıcak Daldırma Galvaniz kaplamalı ürünlerin, birim ağırlığıdır.
Weight* This weight is unit weight of Pregalvanized products. Weight** This weight is unit weight of Hot-dip galvanization coated products.
Вс* Вес единицы предварительной оцинкованных изделий. Вес** Вес единицы оцинкованных изделий горячим погружением.

KANALSAN

www.kanalsan.com.tr

Tij Montaj Örnekleri

Installation Examples of Threaded Rod
Примеры резьбового монтажа

